

Product Image

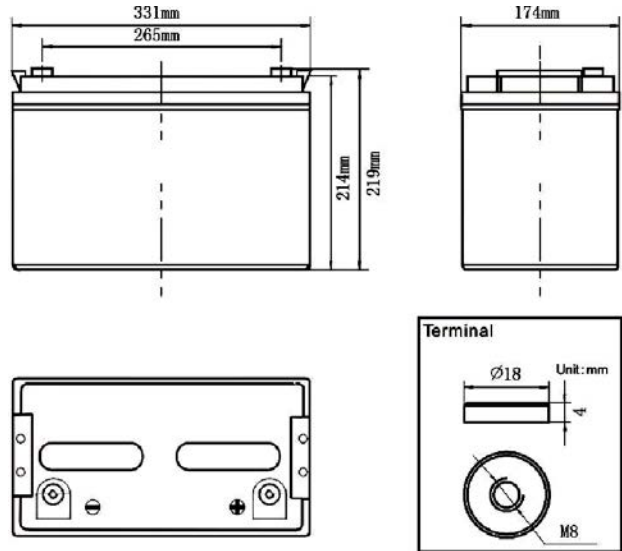

Product Dimensions



Characteristics

| | | |
|---|---------------------------|--|
| Nominal Voltage | | 12V |
| Nominal Solar Capacity (100 hour rate) | | 140Ah |
| Capacity 25°C (77°F) | 20 hour rate (5.55A) | 111.0Ah |
| | 5 hour rate (18.3A) | 91.5Ah |
| | 1 hour rate (66.5A) | 66.5Ah |
| Internal Resistance | Full Charged Battery 25°C | ≤5.0m Ω |
| Capacity affected by Temperature (10 hour) | 40°C (104°F) | 102% |
| | 25°C (77°F) | 100% |
| | 0°C (32°F) | 85% |
| | -15°C (5°F) | 65% |
| Self-Discharge 25°C (77°F) Capacity | after 3 month storage | 90% |
| | after 6 month storage | 80% |
| | after 12 month storage | 62% |
| Charge (Constant Voltage) 25°C (77°F) | Float | Initial Charging Current Less than 25.0A Voltage 13.6-13.8V |
| | Cycle | Initial Charging Current Less than 25.0A Voltage 14.4-14.9V |

Packaging

| | | |
|-----------------------|-----------------|--------------|
| Battery Dimensions | Length | 331mm |
| | Width | 174mm |
| | Height | 214mm |
| | Total Height | 219mm |
| Box Dimensions | Length | 346mm |
| | Width | 188mm |
| | Height | 289mm |
| Quantity Per Box | | 1 PC per box |
| Net weight Per Cell | | 30.0kg±400g |
| Net weight Per Box | | 30.0kg |
| Gross Weight | | 30.5kg |

Discharge Constant Current per Cell (Amperes at 77°F 25°C)

| F.V/Time | 5min | 10min | 15min | 30min | 45min | 1h | 2h | 3h | 5h | 8h | 10h | 20h |
|----------|-------|-------|-------|-------|-------|------|------|------|------|------|-------|------|
| 1.60V | 336.3 | 224.0 | 168.8 | 105.1 | 75.4 | 66.5 | 40.5 | 29.6 | 19.1 | 11.6 | 10.40 | 5.77 |
| 1.65V | 310.0 | 206.5 | 161.8 | 102.2 | 73.4 | 64.7 | 39.8 | 29.1 | 18.8 | 11.5 | 10.30 | 5.72 |
| 1.70V | 315.2 | 210.0 | 154.8 | 99.4 | 71.3 | 63.0 | 39.1 | 28.6 | 18.5 | 11.4 | 10.20 | 5.66 |
| 1.75V | 278.5 | 185.5 | 147.7 | 96.6 | 69.3 | 61.2 | 38.1 | 27.9 | 18.3 | 11.3 | 10.10 | 5.61 |
| 1.80V | 262.7 | 175.0 | 140.7 | 93.8 | 67.3 | 59.4 | 37.2 | 27.2 | 18.0 | 11.2 | 10.00 | 5.55 |

Discharge Constant Power per Cell (Watts at 77°F 25°C)

| F.V/Time | 5min | 10min | 15min | 30min | 45min | 1h | 2h | 3h | 5h | 8h | 10h | 20h |
|----------|-------|-------|-------|-------|-------|-------|------|------|------|------|------|------|
| 1.60V | 627.1 | 417.8 | 314.9 | 195.9 | 140.6 | 124.1 | 75.6 | 55.3 | 35.6 | 21.7 | 19.4 | 10.8 |
| 1.65V | 578.1 | 385.1 | 301.8 | 190.7 | 136.8 | 120.8 | 74.2 | 54.3 | 35.1 | 21.5 | 19.2 | 10.7 |
| 1.70V | 587.9 | 391.7 | 288.6 | 185.4 | 133.0 | 117.4 | 72.8 | 53.3 | 34.6 | 21.3 | 19.0 | 10.6 |
| 1.75V | 519.3 | 346.0 | 275.5 | 180.2 | 129.3 | 114.1 | 71.1 | 52.0 | 34.1 | 21.1 | 18.8 | 10.5 |
| 1.80V | 489.9 | 326.4 | 262.4 | 174.9 | 125.5 | 110.8 | 69.4 | 50.7 | 33.6 | 20.9 | 18.7 | 10.4 |

Note The above data are average values, and can be obtained within 3 charge/discharge cycles. These are not minimum values. Cell and battery designs/specifications are subject to modification without notice. Contact TWb for the latest information.

Performance Characteristics

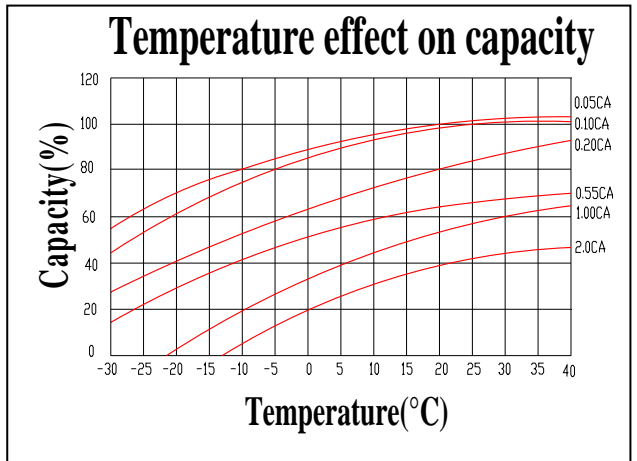
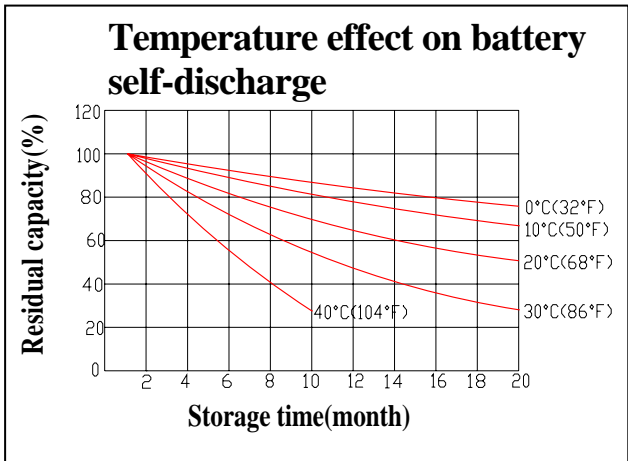
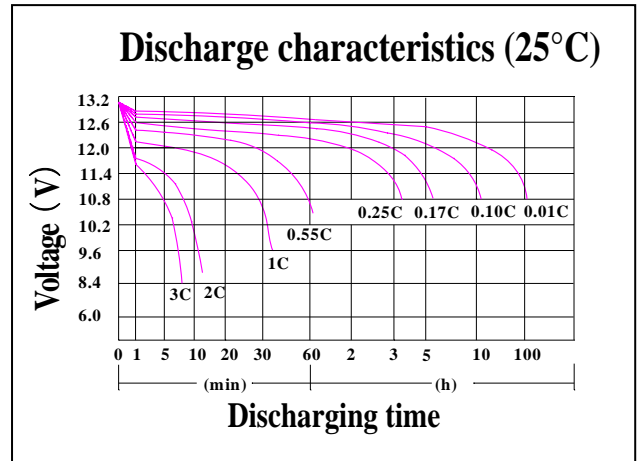
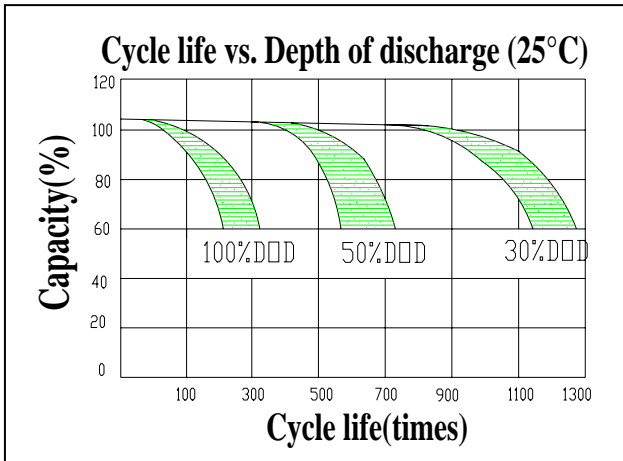
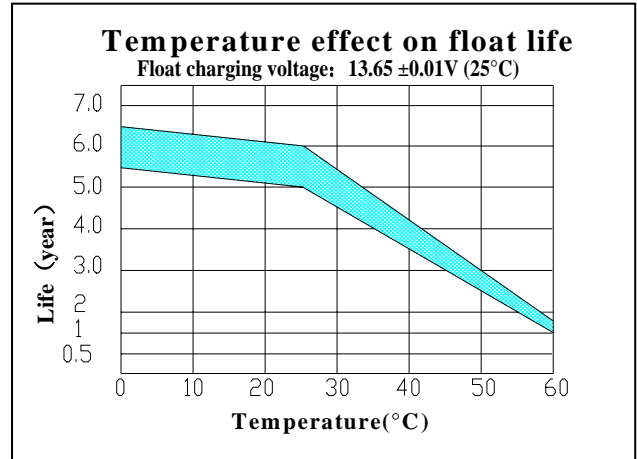
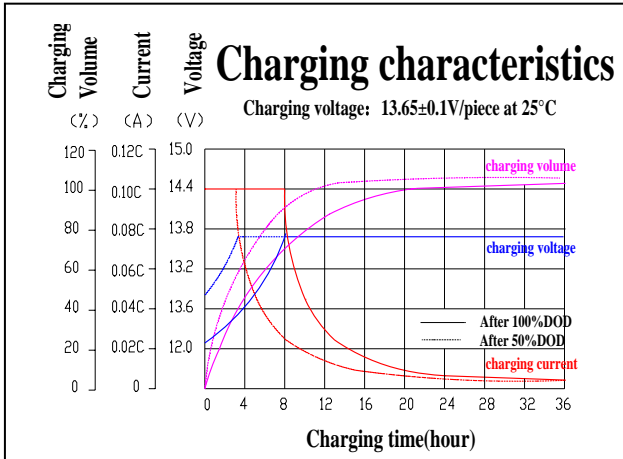

Battery Construction

| Component | Positive plate | Negative plate | Container | Cover | Safety valve | Terminal | Separator | Electrolyte |
|--------------|----------------|----------------|-----------|-------|--------------|----------|------------|---------------|
| Raw material | Lead dioxide | Lead | ABS | ABS | Si-Rubber | Copper | Fiberglass | Sulfuric acid |

Note The above data are average values, and can be obtained within 3 charge/discharge cycles. These are not minimum values. Cell and battery designs/specifications are subject to modification without notice. Contact TWb for the latest information.